

Product Parts Breakdown

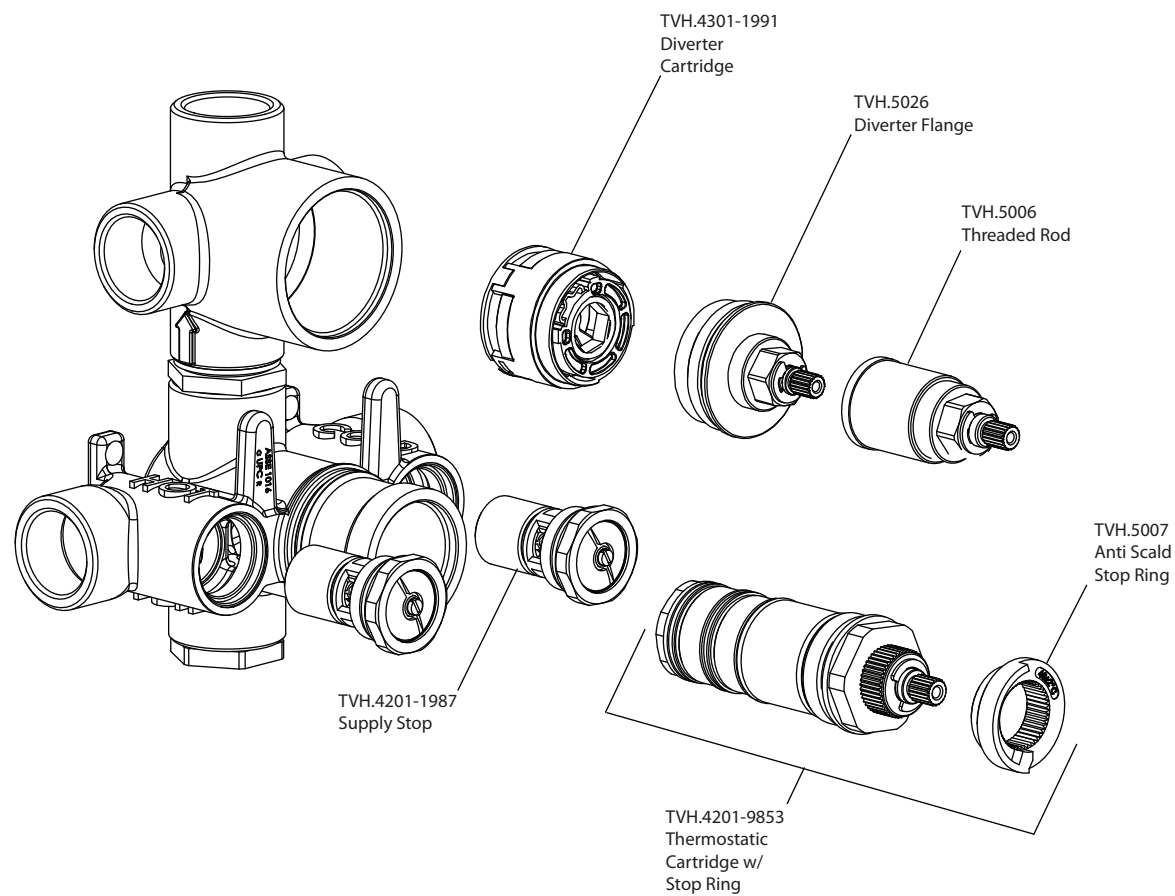

isenberg
innovation+design

TVH.4301

Ver 2.53